

T5

T1 1r
Sper



1mm
errholz



T6

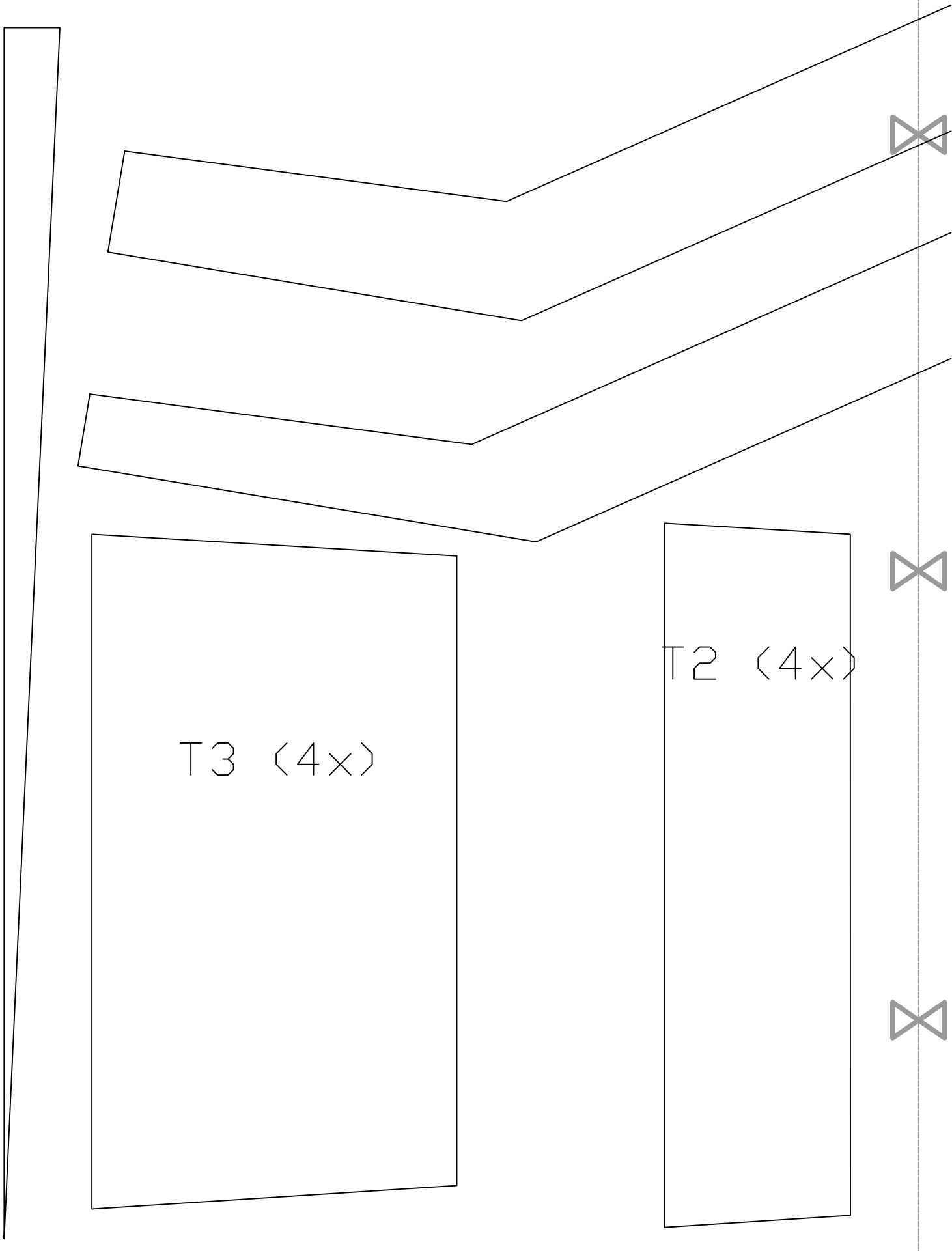

G1 (4x)

1mm Sperrholz

G2 (2x)

6mm Depron

A1 (12x)

A3 (6x)

A2 (2x)

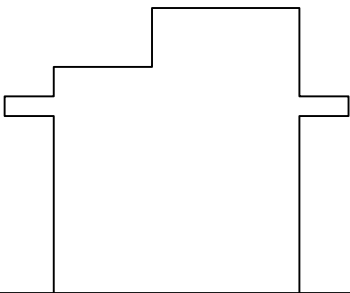

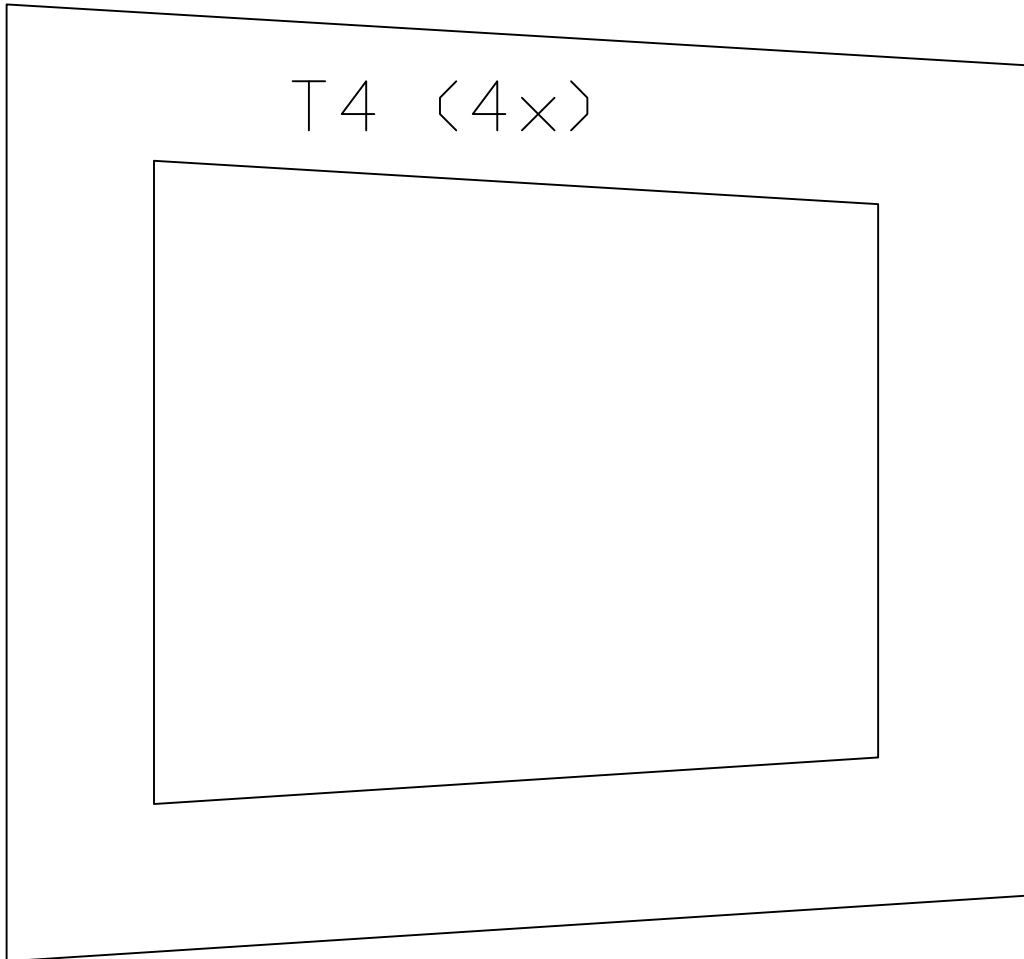
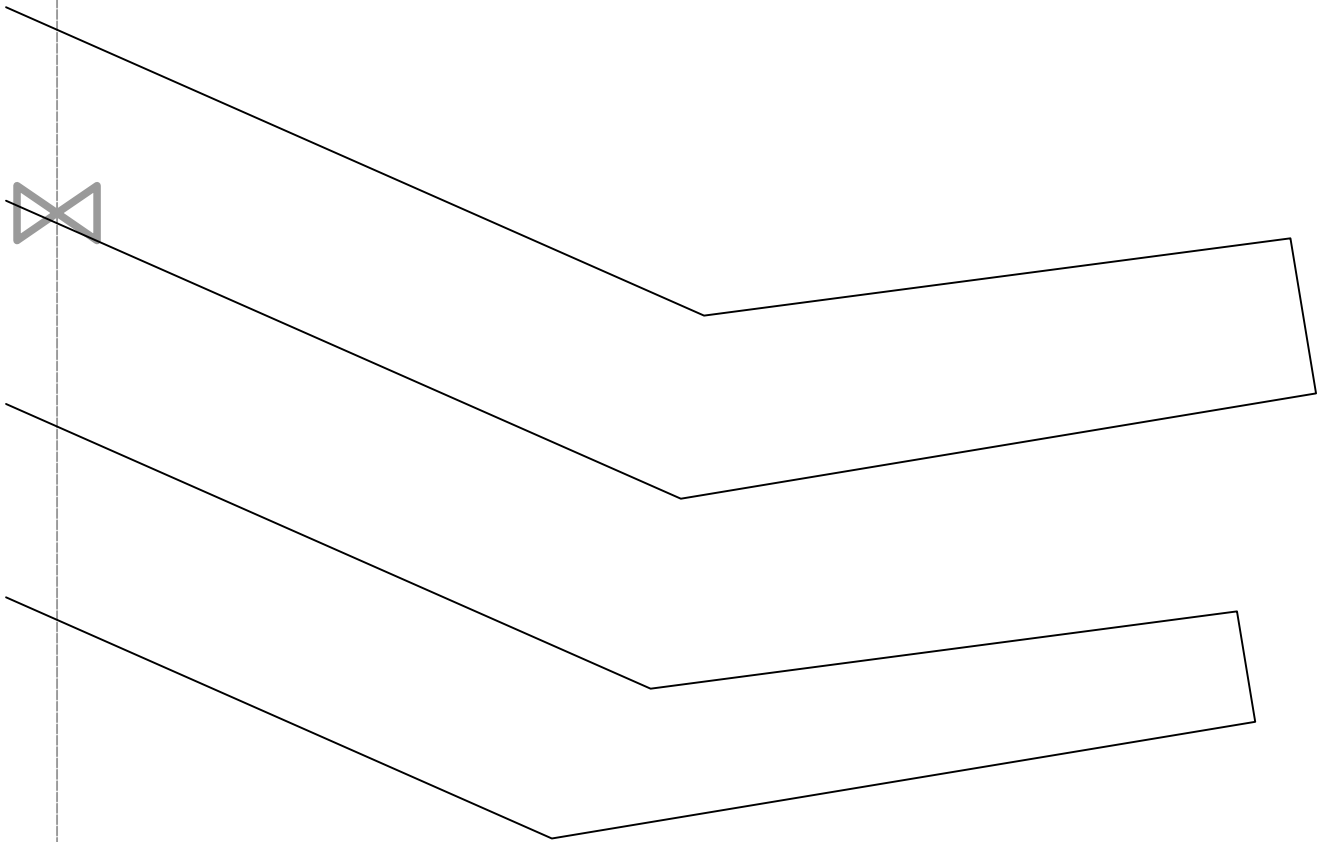

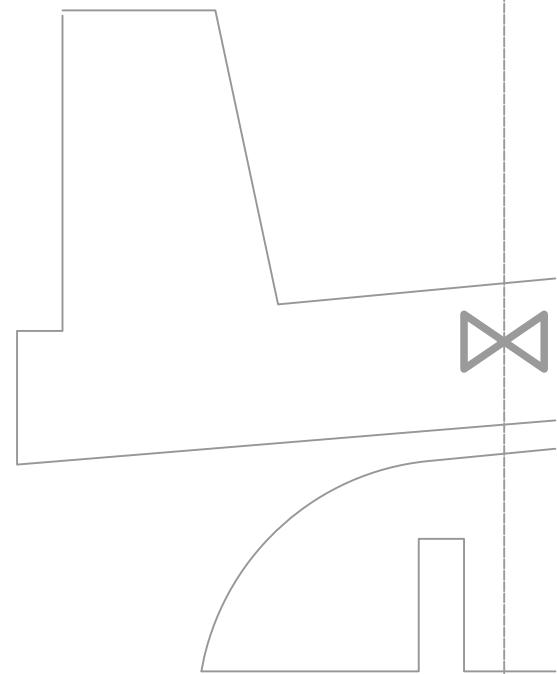
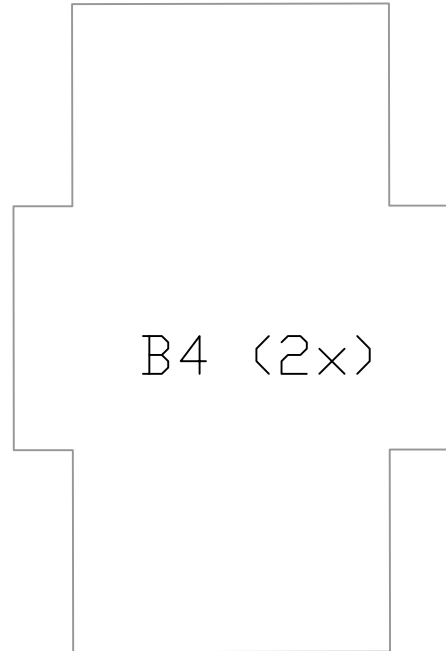
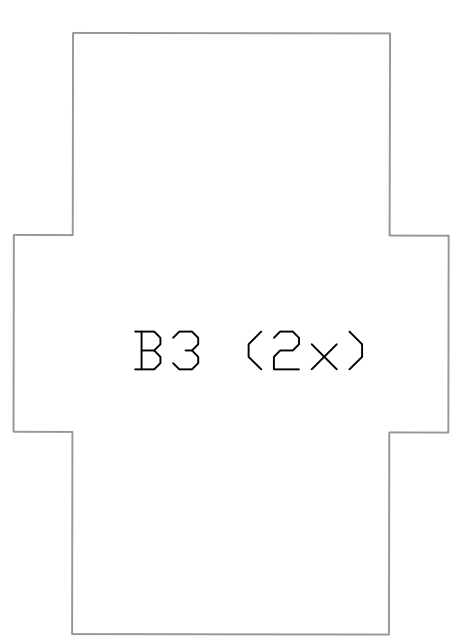
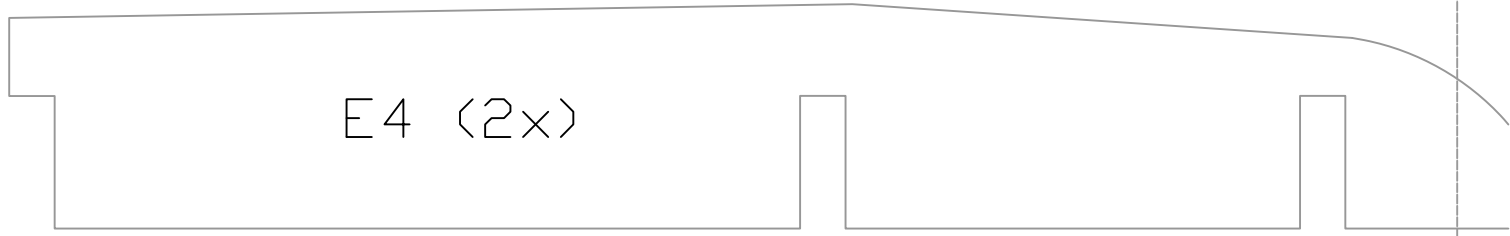
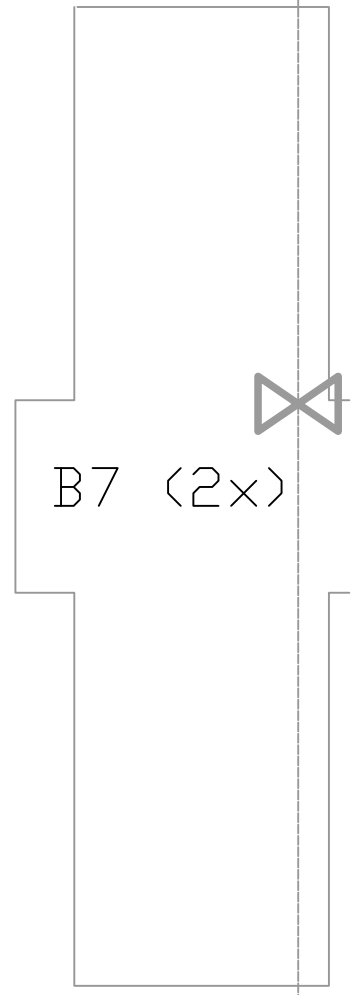

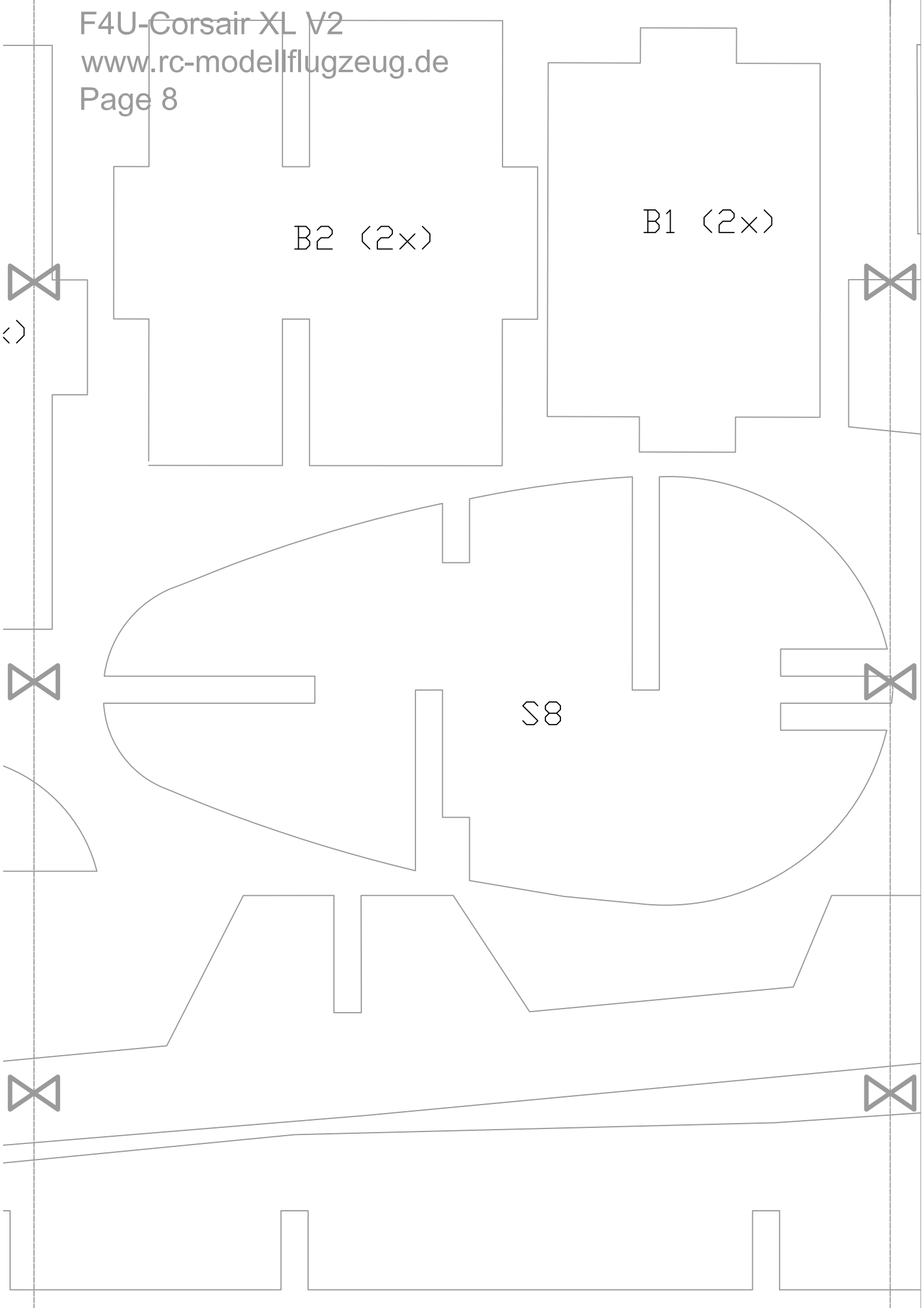

B2 (2x)

B1 (2x)

S8



C

B5 (2x)

B6 (2x)

R1 (2x)

E5 (2x)



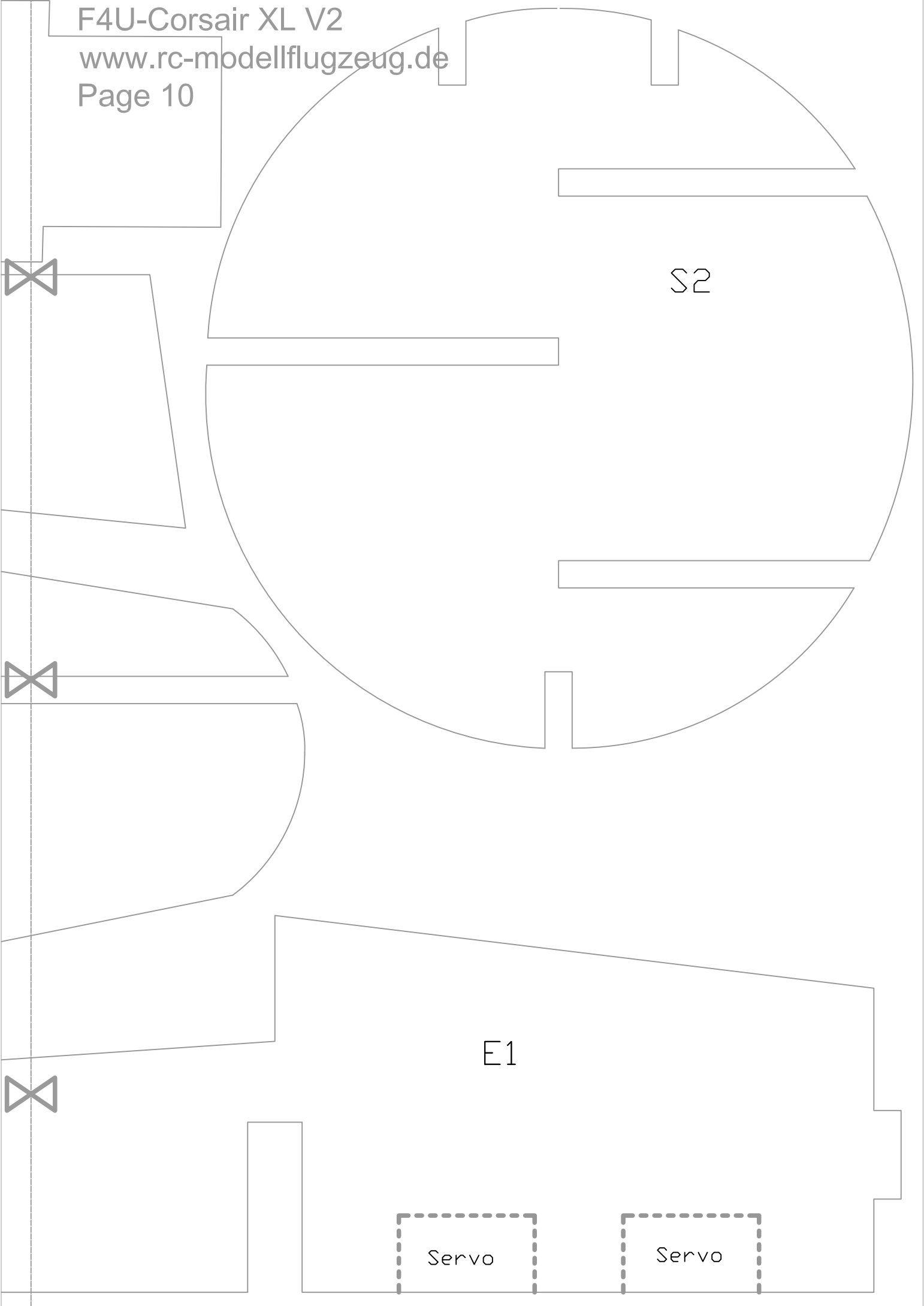

S2

E1

Servo

Servo

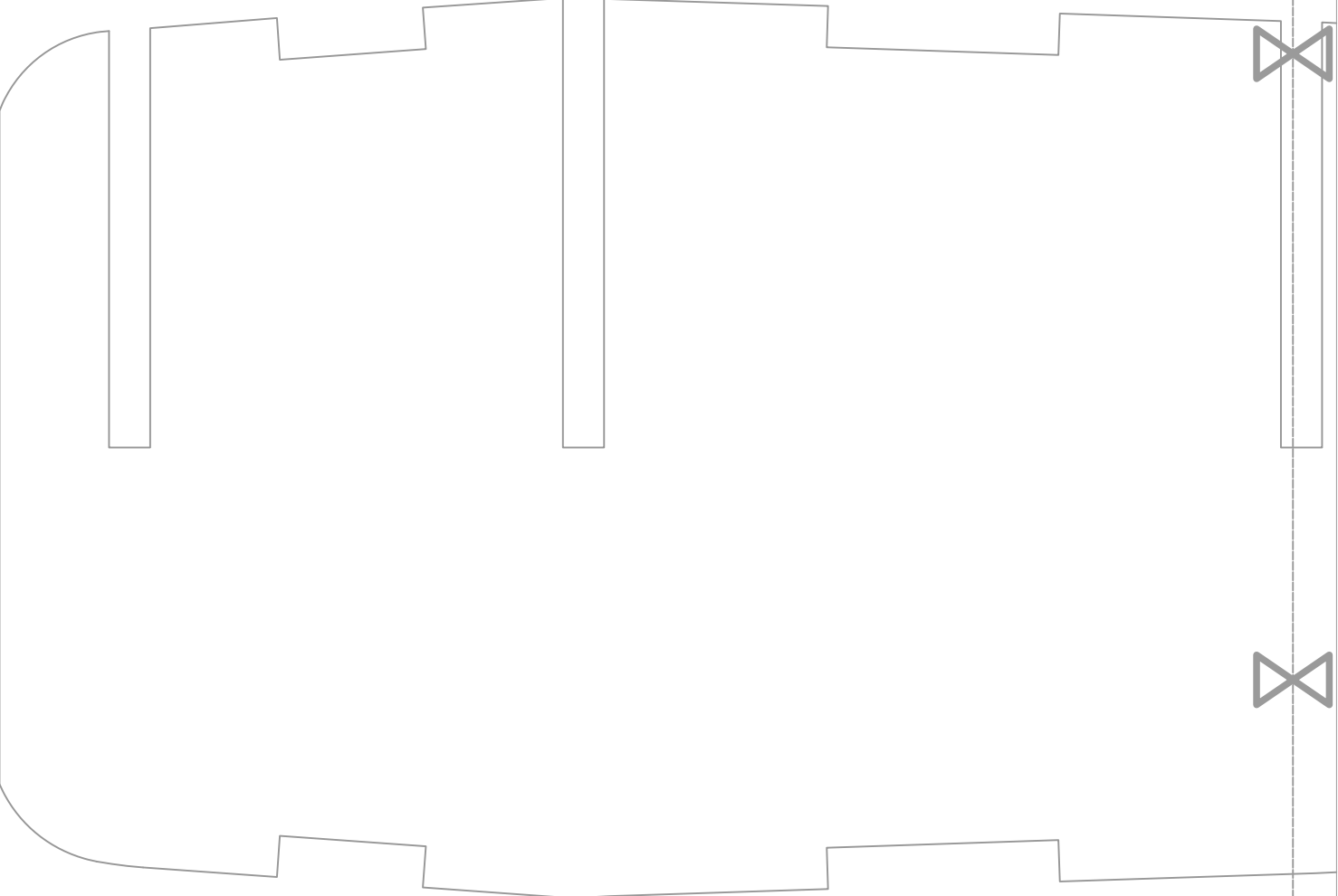
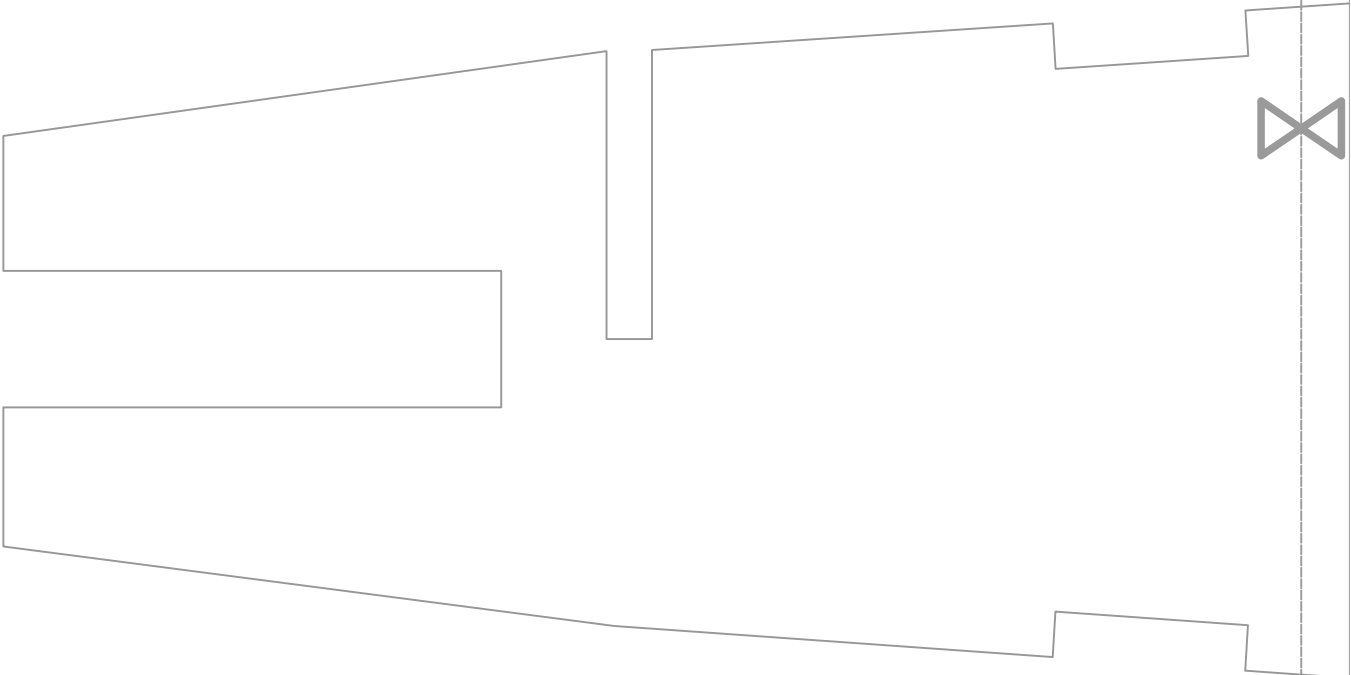

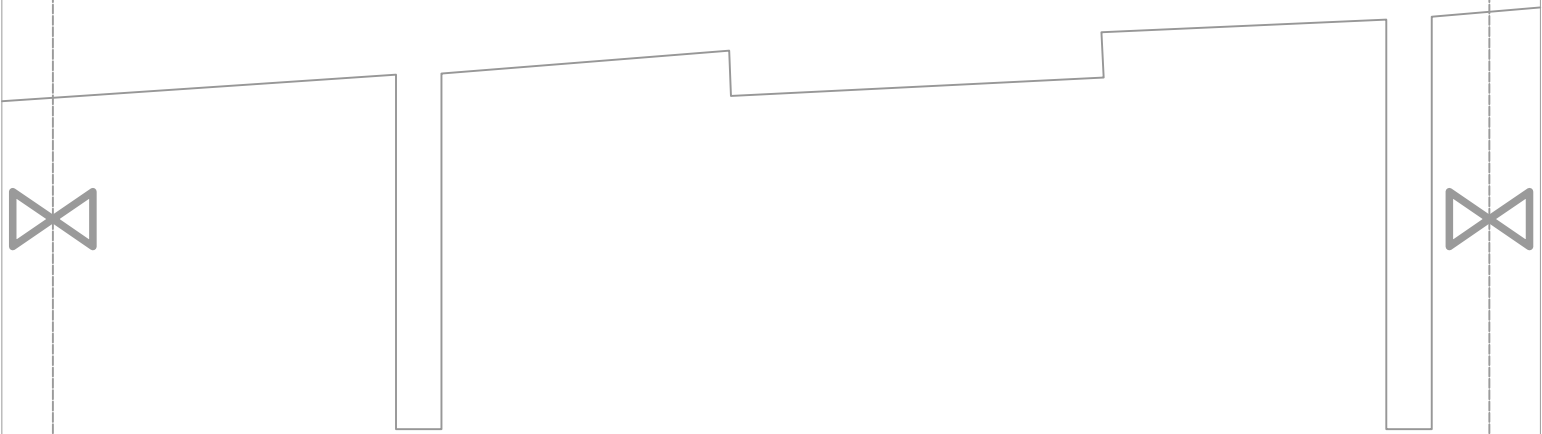

H1

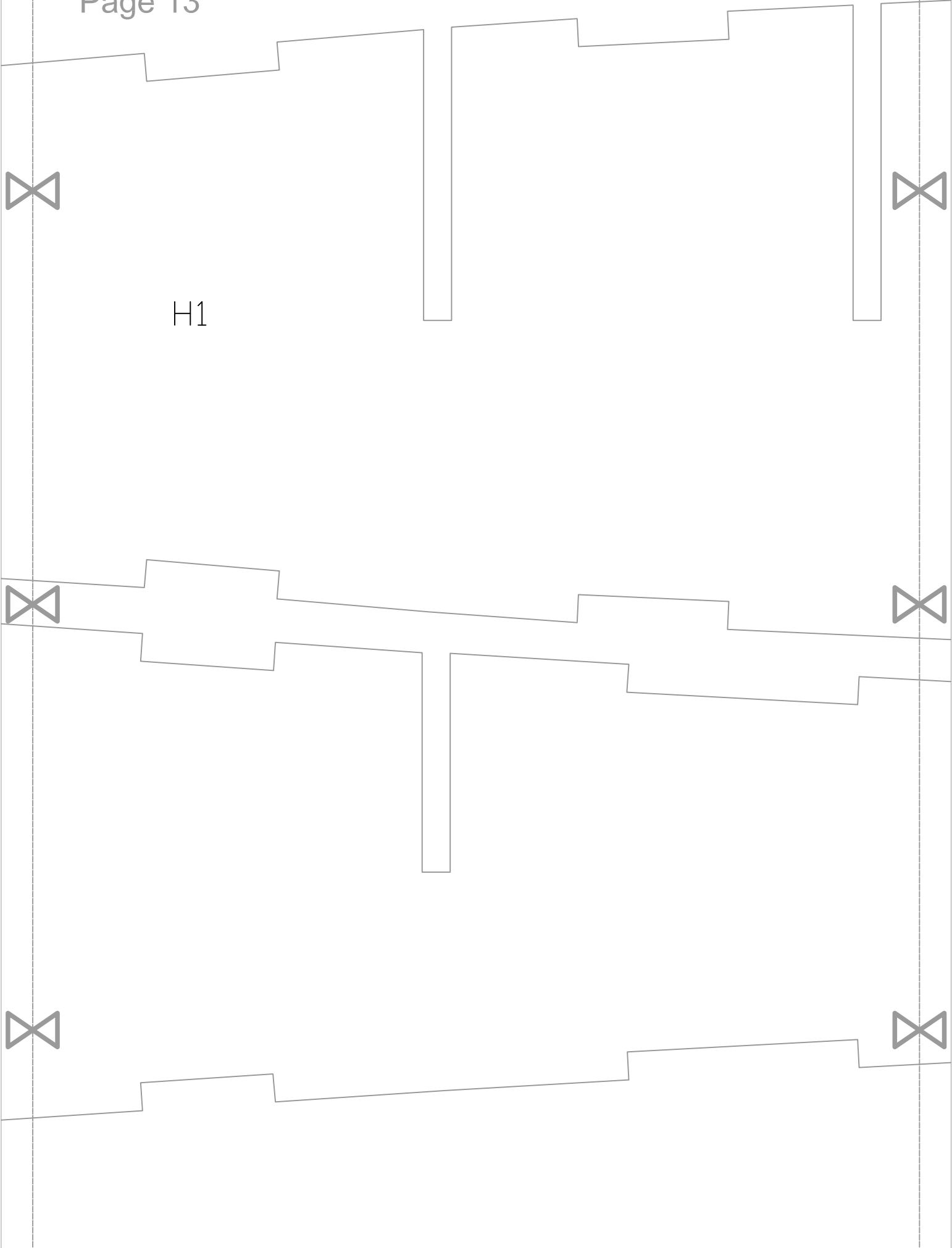



S3

R2

S6

L1

Add Page 15

Add Page 17



E2

S10

S7

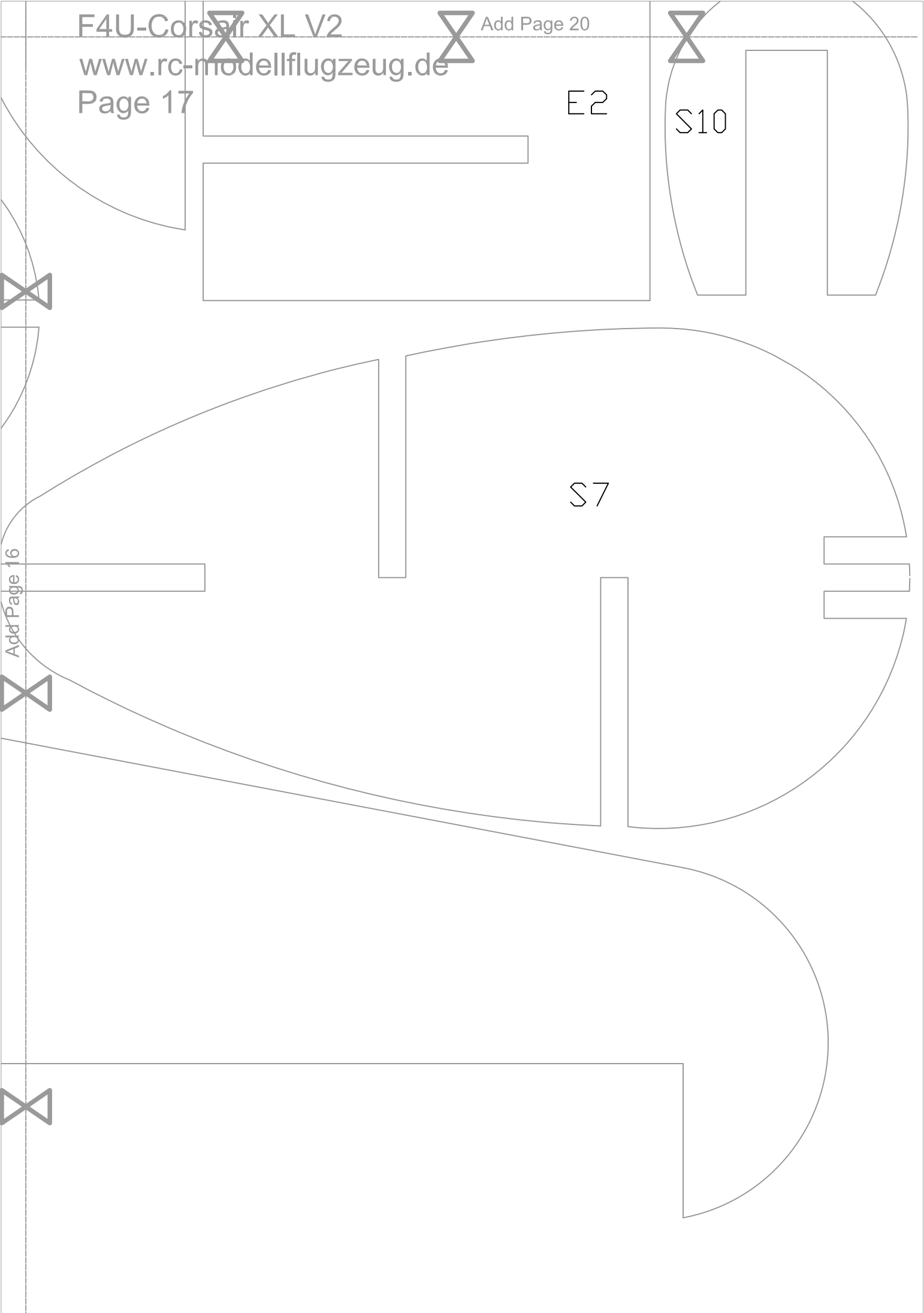

H3

E3

S5



Add Page 19

Add Page 15

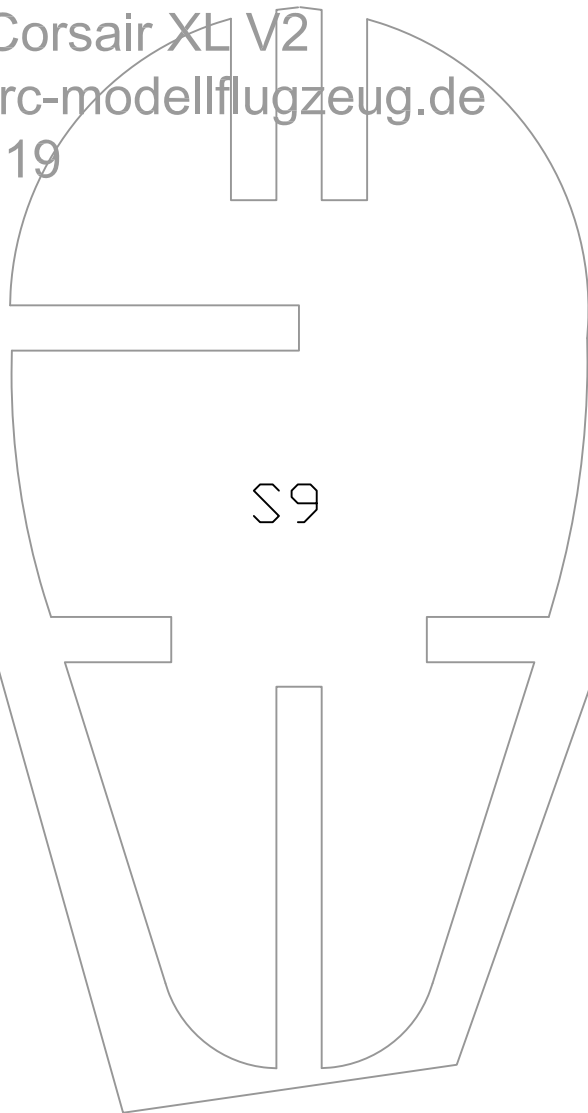

S9

E4



Add Page 18

Add Page 20

Add Page 16

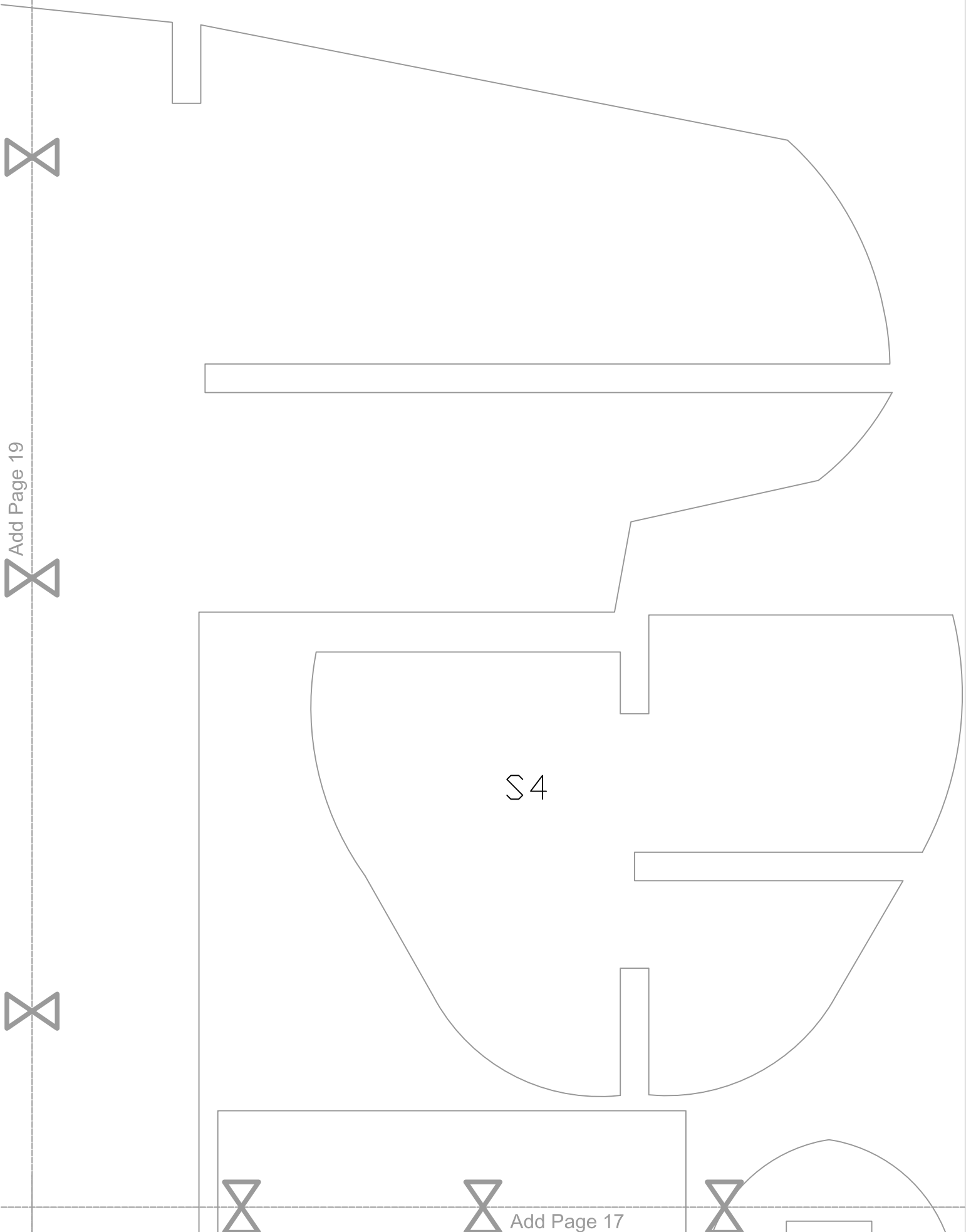

Add Page 19

S4

Add Page 17

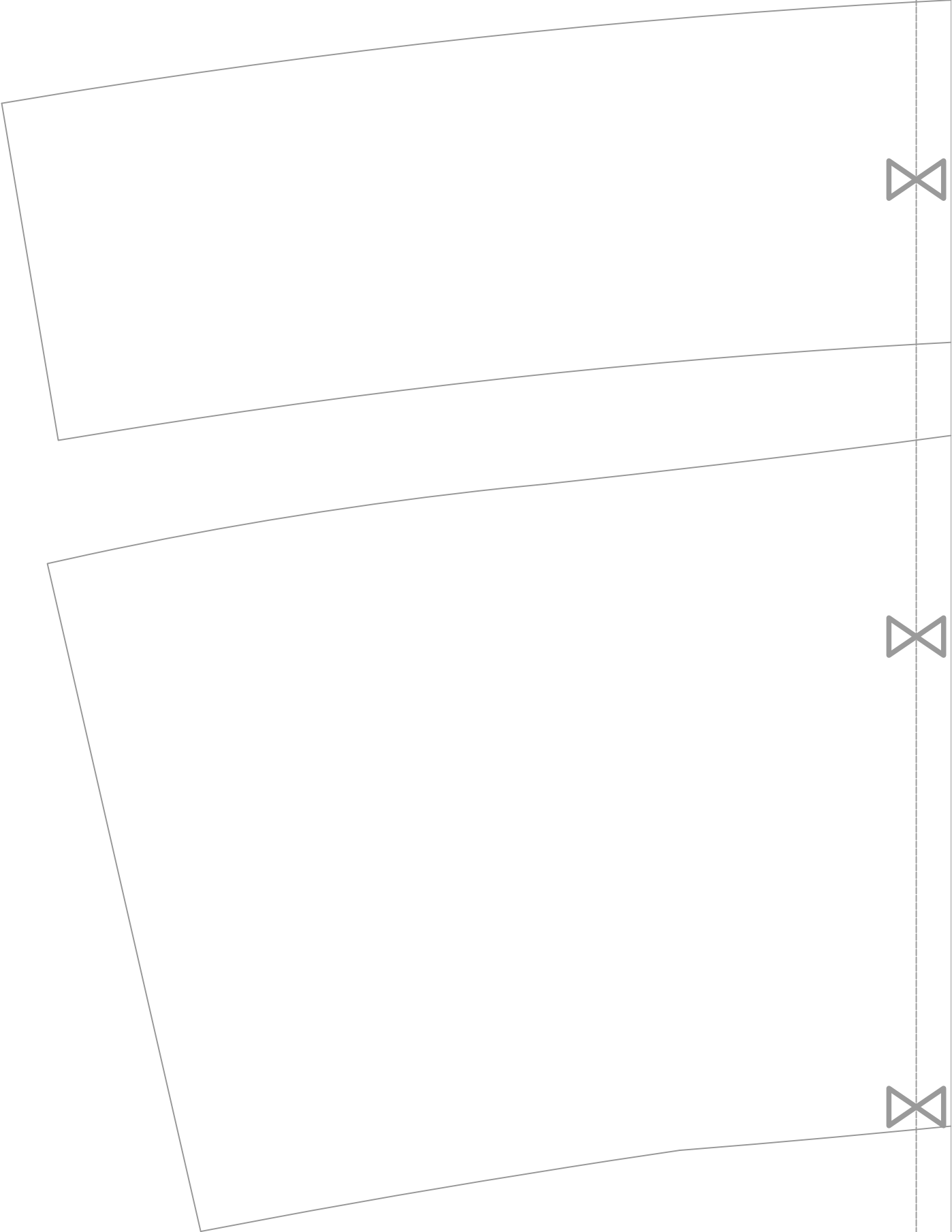



M1 (3mm Depron)



M4 (3mm Depron)



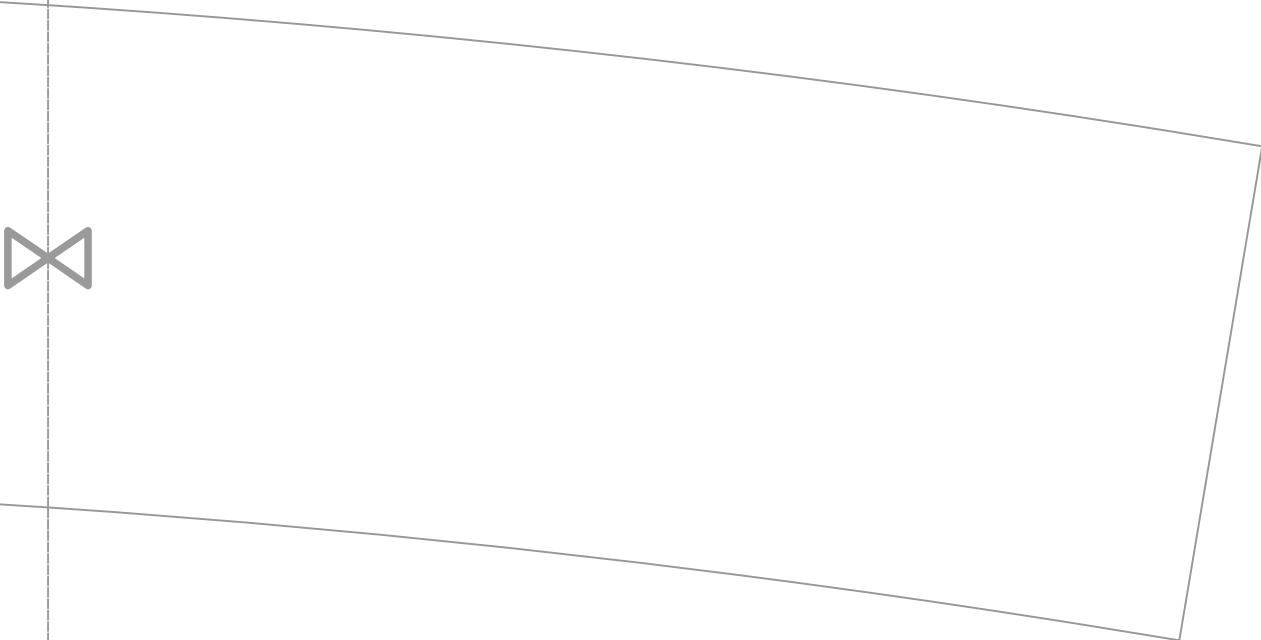

M3 (3mm Depron)



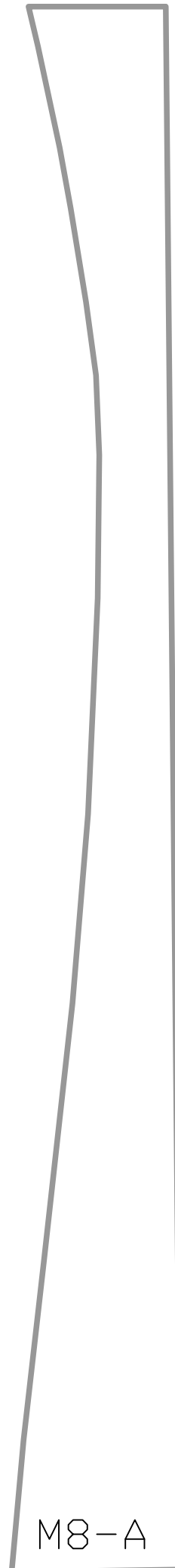



M7 (3mm Depron)



[W1

[W1



M2 (3mm Depron)



M9 (2x) (3





(3mm Depron)



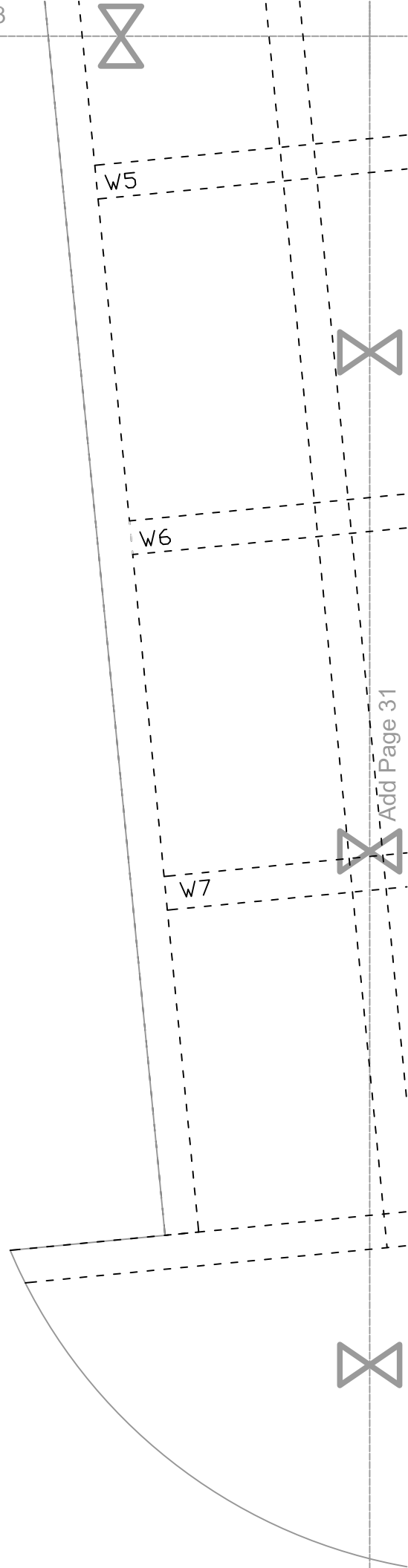
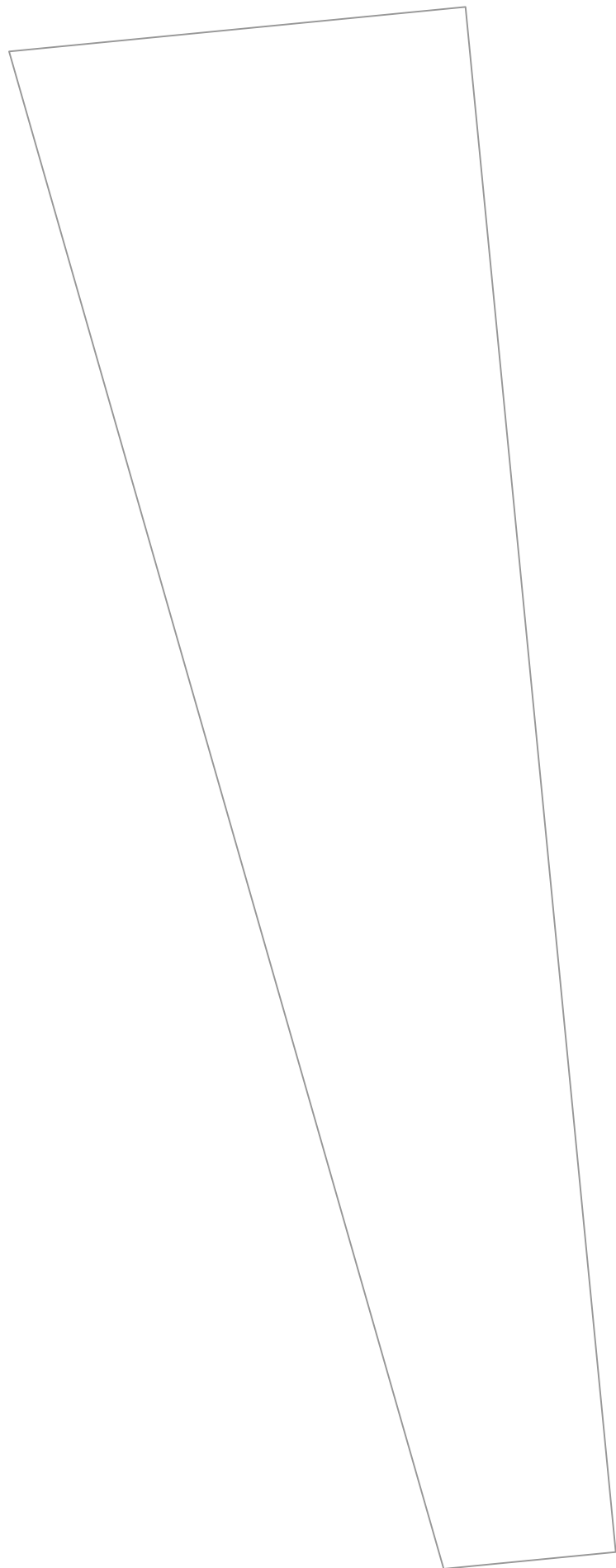

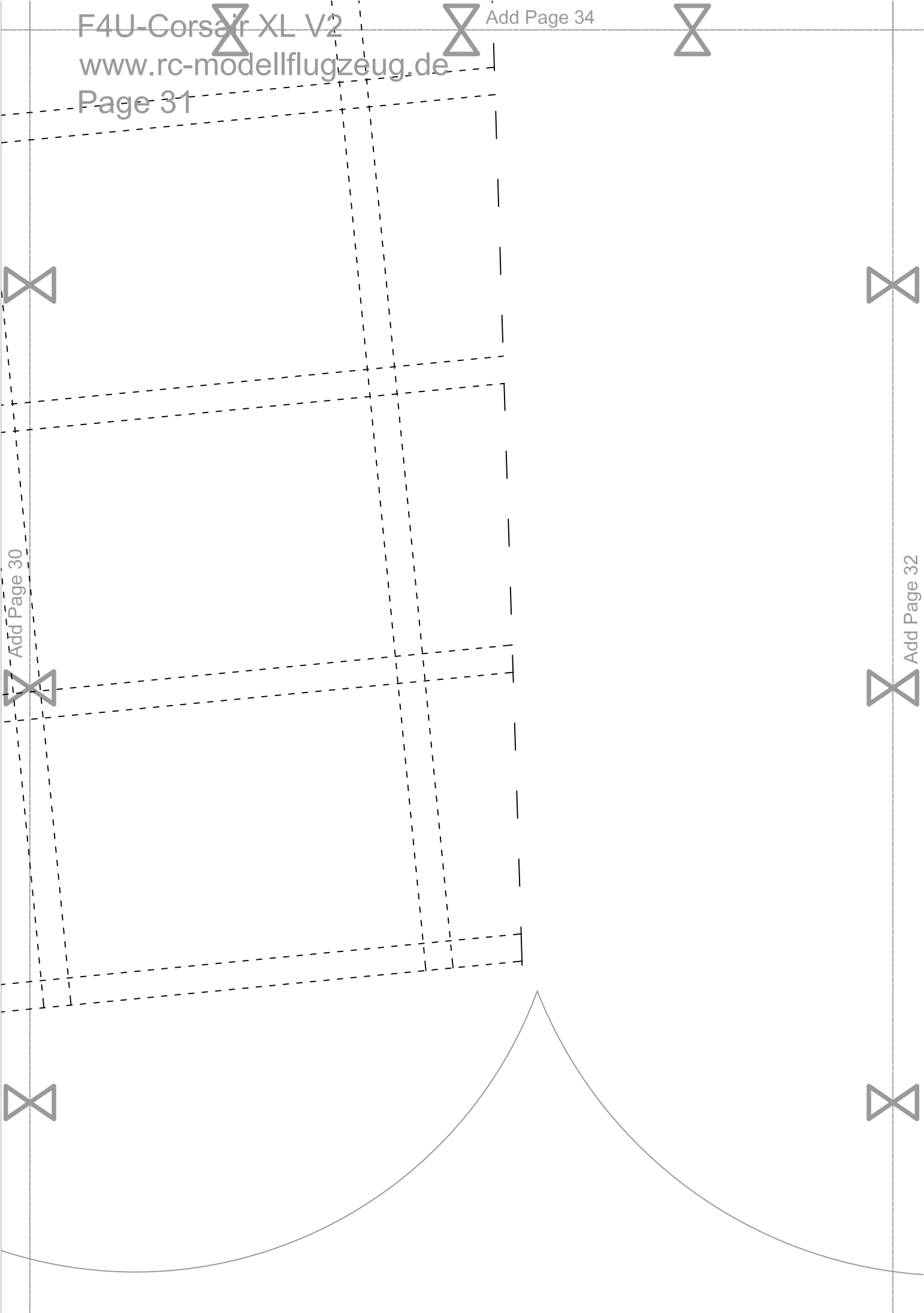

Add Page 30

Add Page 32



Add Page 31

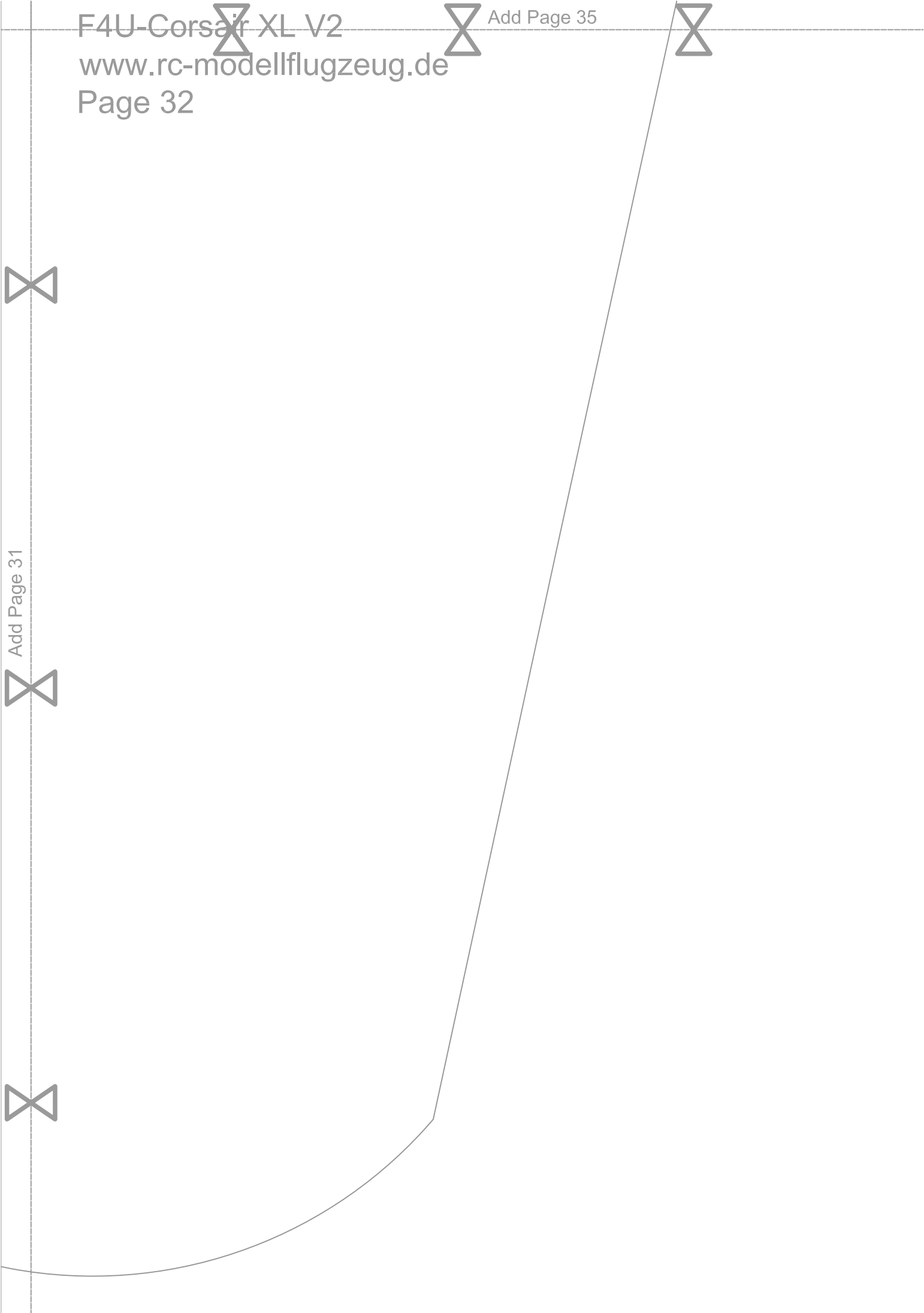

w1

w2

w3

w4

Unterseite



Add Page 34

Add Page 30



Add Page 33



Add Page 35



M6 (2x) (3mm D



Add Page 31



Depron)



Add Page 32



Add Page 34

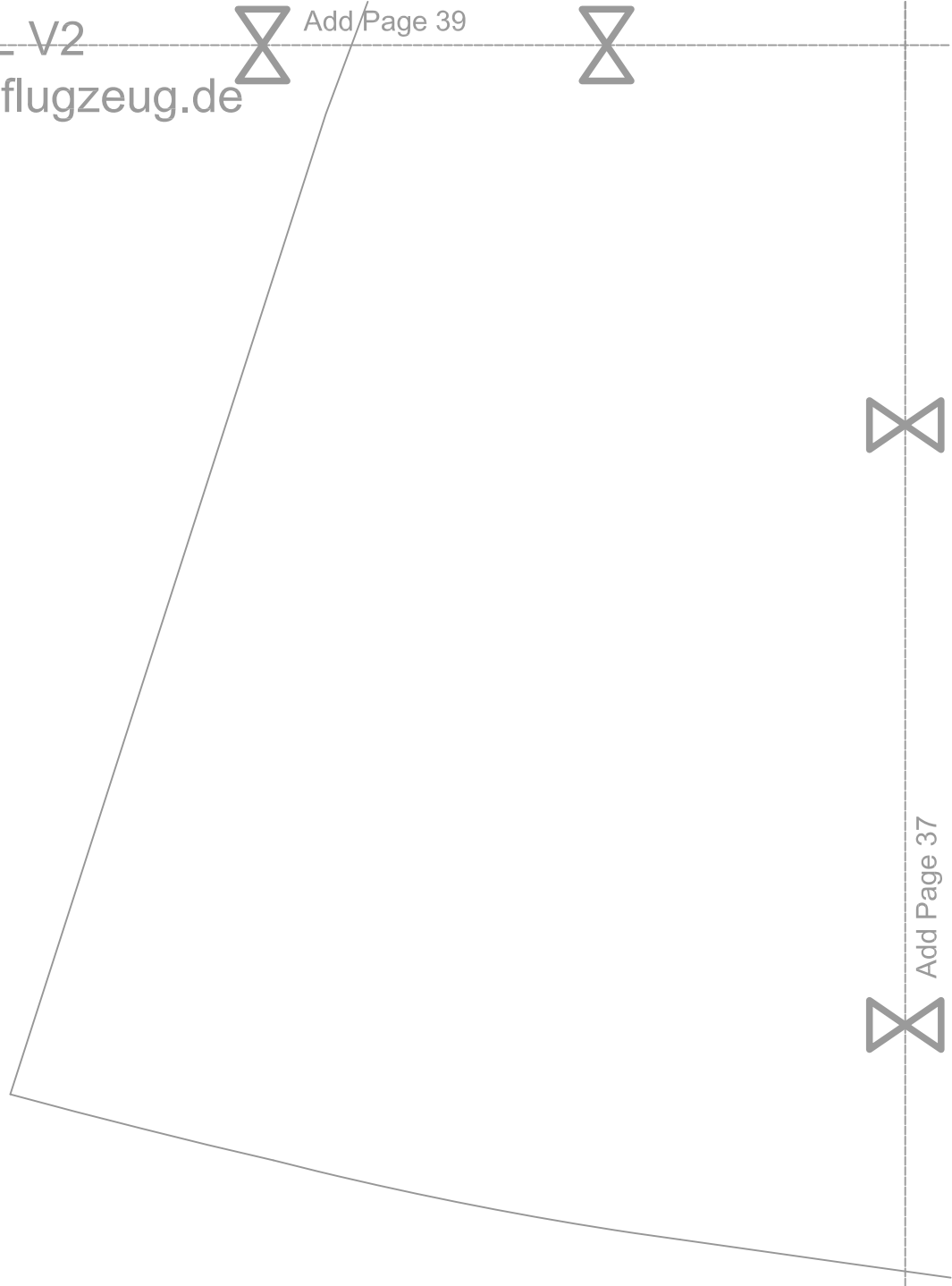

M5 (3mm Depron)

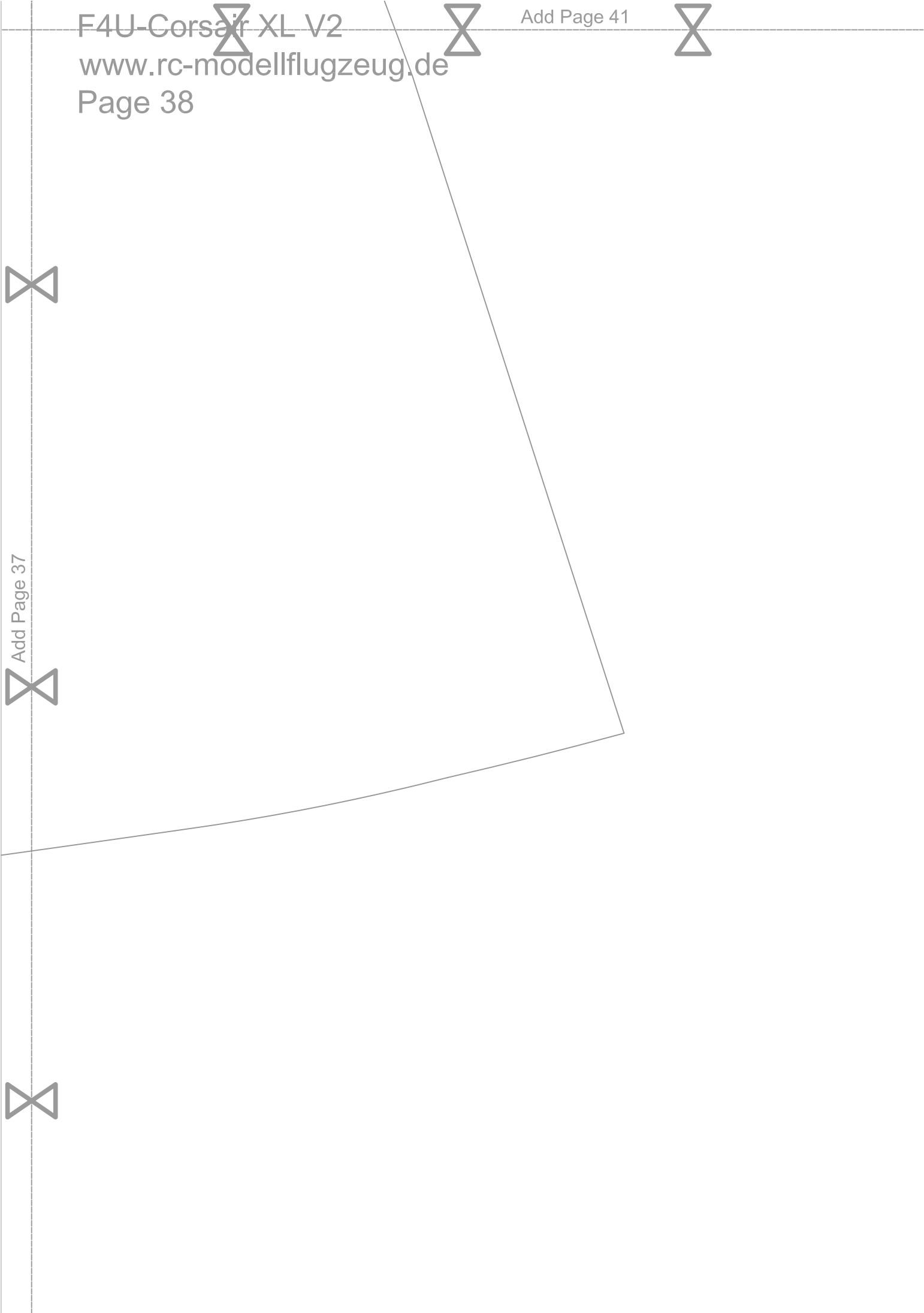



Add Page 36



Add Page 40





Add Page 39



Add Page 41



Add Page 37



Add Page 40

Add Page 38